

DATA SHEET

## F200 B Type



Cutting-edge features: safety, service continuity, compactness, integration. These are the characteristics of the F200 B RCCBs (residual current circuit breakers), the state-of-the-art technology by ABB which has been providing the best solutions for residential, commercial and industrial installations for over 120 years.

—  
01  
F202 B and F204 B:  
residual current  
circuit breakers

Type B RCCBs can be adapted perfectly to all types of installation requirements and application fields.

F200 B is compliant to product standard IEC/EN 61008 and EN 62423 and features the following main technical characteristics:

- Rated current: from 16 A to 125 A
- Sensitivity: 30, 300 and 500 mA
- Operating temperature: -25 °C to +70 °C (for system up to 32 A)
- Pollution degree 3 (for 16–63 A devices, 30–300 mA)

### Applications benefits:

- Terminals equipped with fail safe feature to avoid improper installation
- Supply possible both from top and bottom and in parallel with cables and busbars thanks to terminals composed by two different seats: a front seat for 25 mm<sup>2</sup> cables and a back seat for 10 mm<sup>2</sup> busbars
- Compact solution with just 2 Pole devices in 2 DIN Module
- Compatible with a wide range of accessories with lots of different functions
- Great performance over time thanks to high immunity against unwanted tripping and robustness to operating environment
- Certified quality and compliance to worldwide product standard

## RCCBs

### F 200 series - B type technical features

		F200 B Type		F200 B Type high ratings	
		F202 B 16-63 A	F204 B 25-63 A	F204 B 80-125 A	
Standards		IEC/EN 61008-1, IEC/EN 61008-2-1, EN 62423			
Electrical features	Type (wave form of the earth leakage sensed)	B	B, B-S	B	
	Poles	2P	4P	4P	
	Rated current $I_n$	A 16, 25, 40, 63	25, 40, 63	80, 125	
	Rated sensitivity $I_{\Delta n}$	A 0,03 - 0,3	0,03 - 0,3 - 0,5	0,03 - 0,3 - 0,5	
	Rated voltage $U_e$	V AC 230	230/400	230/400	
	Insulation voltage $U_i$	V 440	440 - 500 <sup>1</sup>	400	
	Operating voltage of circuit test $U_t$	IEC/EN V 110 - 253 V AC 170 - 253 V AC (30 mA)	110 - 253 V AC 170 - 253 V AC (30 mA)	150 - 250 V AC (80 A) 200 - 250 V AC (80 A, 30 mA) 200 - 440 V AC (125 A) 250 - 440 V AC (125A, 30 mA)	
	Min. operating voltage for detecting Type A/AC/F residual currents	V AC 0	0	0	
	Min. operating voltage for detecting Type B residual currents	V AC 50	50	50	
	Rated frequency	Hz 50/60	50/60	50	
	Frequency range of residual current	kHz 2	2	100	
	Rated conditional short-circuit current $I_{nc}=I_A^3$	SCPD - fuse gG/gL 100 A kA 10	10	10 (fuse gG 125 A)	
	Rated residual breaking capacity $I_{\Delta n}=I_m$	kA 1	1	125 A: 1,25 80 A: 1	
	Rated impulse withstand voltage (1.2/50) $U_{imp}$	kV 4	4	4	
	Dielectric test voltage at ind. freq. for 1 min.	kV 2,5	2,5	2,5	
	Overvoltage category	III, disconnector abilities			
	Surge current resistance (wave 8/20)	A 3.000	3.000 - 5.000 (B S)	3.000 - 5.000 (B S)	
	Maximum electronic consumption	W 0,3	1,2 (3,5 <sup>1</sup> )		
	Mechanical features	Toggle	Blue sealable in ON-OFF		
		Contact position indicator (CPI)	yes	yes	yes
Electrical life		10.000	10.000	2.000	
Mechanical life		20.000	20.000	5.000	
Protection degree		housing terminals	IP4X IP2X	IP4X IP2X	IP4X IP2X
Environmental conditions (damp heat) acc. to IEC/EN 60068-2-30		°C/RH	28 cycles with 55°C/90-96% and 25°C/95-100%		
Ambient temperature		IEC °C	-25...+70 (for system current ≤ 32 A) <sup>4</sup> -25...+65 for system current = 40 A <sup>4</sup> -25...+50 for system current = 63 A <sup>4</sup> For other system current see derating table		
Storage temperature		°C	40...+70		
Installation		Terminal Type	Failsafe bi-directional cylinder-lift terminal at top and bottom (shock protected) (cage for $I_n > 63 A$ ) <sup>2</sup>		
		Min/Max Terminal size top/bottom for cable	IEC Mm <sup>2</sup>	1 - 25	50
	Terminal size top/bottom for busbar	IEC Mm <sup>2</sup>	10/10	10/10	
	Tightening torque	IEC Nm	2,8	3	
	Tool	Flat tip PZ2			
	Mounting	Any position on DIN rail EN 60715 (35 mm) by means of fast clip device			
	Supply	Top/bottom			
	Withdrawal from busbar	It is possible without using any tools only from the bottom			
Dimensions and weight	Dimensions (H x D x W)	2P Mm	85 x 69 x 35	85 x 69 x 70	
	Weight	2P g	200	380	
Combination with auxiliary elements <sup>3</sup>	Combinable with:				
	auxiliary contact	yes	yes	no	
	signal contact/auxiliary switch	yes	yes	yes	
	motor operating device	yes	yes	no	
	shunt trip	yes	yes	no	
undervoltage release	yes	yes	no		

<sup>1</sup> 500 mA devices

<sup>2</sup> Prior to connection of aluminium conductors (≥ 4 mm<sup>2</sup>) ensure that their contact points are cleaned, brushed and coated with grease

<sup>3</sup> For S750-E 63 A, S750DR-E/K 100 A and other SCPD back up coordination values are available.

<sup>4</sup> Constant temperature.

<sup>5</sup> With daily average < 35°C.

## RCCBs

F 200 series - B type   



F202 B



F204 B

### F200 B Type from 16 to 63 A

Number of poles	Rated residual current $I_{\Delta n}$ mA	Rated current $I_n$ A	Bbn 8012542 EAN	Order details		Weight 1 piece kg	Pack unit pc.
				Type code	Order code		
2	30	16	341154	F202 B-16/0,03	2CSF202568R1160	0,220	1
		25	341253	F202 B-25/0,03	2CSF202568R1250	0,220	1
		40	341352	F202 B-40/0,03	2CSF202568R1400	0,220	1
		63	341154	F202 B-63/0,03	2CSF202568R1630	0,220	1
	300	16	341451	F202 B-16/0,3	2CSF202568R3160	0,220	1
		25	341550	F202 B-25/0,3	2CSF202568R3250	0,220	1
4	30	40	341659	F202 B-40/0,3	2CSF202568R3400	0,220	1
		63	341758	F202 B-63/0,3	2CSF202568R3630	0,220	1
		25	341857	F204 B-25/0,03	2CSF204568R1250	0,380	1
		40	341956	F204 B-40/0,03	2CSF204568R1400	0,380	1
	300	63	342052	F204 B-63/0,03	2CSF204568R1630	0,380	1
		25	342151	F204 B-25/0,3	2CSF204568R3250	0,380	1
		40	342250	F204 B-40/0,3	2CSF204568R3400	0,380	1
	300 S	63	342359	F204 B-63/0,3	2CSF204568R3630	0,380	1
		40	342458	F204 B S-40/0,3	2CSF204868R3400	0,380	1
		63	342557	F204 B S-63/0,3	2CSF204868R3630	0,380	1
		40	776932	F204 B-40/0,5 <sup>2</sup>	2CSF204592R4400	0,380	1
	500	63	347637	F204 B-63/0,5 <sup>2</sup>	2CSF204592R4630	0,380	1
40		357834	F204 B S-40/0,5 <sup>2</sup>	2CSF204892R4400	0,380	1	
500 S	63	347538	F204 B S-63/0,5 <sup>2</sup>	2CSF204892R4630	0,380	1	
	25	356356	F202 B-25/0,03 U	2CSF202568U1250	0,220	48	
4	30	25	356158	F204 B-25/0,03 U	2CSF204568U1250	0,380	24
		40	355953	F204 B-40/0,03 U	2CSF204568U1400	0,380	24
		63	356059	F204 B-63/0,03 U	2CSF204568U1630	0,380	24
	300	63	356257	F204 B-63/0,3 U	2CSF204568U3630	0,380	24

### F200 B Type high ratings

Number of poles	Rated residual current $I_{\Delta n}$ mA	Rated current $I_n$ A	Bbn 8012542 EAN	Order details		Weight 1 piece kg	Pack unit pc.
				Type code	Order code		
4	30	80	988601	F204B-80/0,03 <sup>2</sup>	2CSF204501R1800	0,46	1
		125	988700	F204B-125/0,03L <sup>1,2</sup>	2CSF204523R1950	0,46	1
	300	80	989103	F204B-80/0,3 <sup>2</sup>	2CSF204501R3800	0,46	1
		125	989202	F204B-125/0,3L <sup>1,2</sup>	2CSF204523R3950	0,46	1
	300 S	125	989509	F204BS-125/0,3L <sup>1,2</sup>	2CSF204823R3950	0,46	1
	500	125	730439	F204B-125/0,5L <sup>1,2</sup>	2CSF204523R4950	0,46	1
	500 S	125	731238	F204BS-125/0,5L <sup>1,2</sup>	2CSF204823R4950	0,46	1

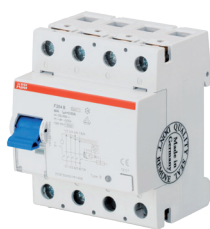

F204 B 80, 125 A

<sup>1</sup> Left-sided neutral pole  
<sup>2</sup> No-self-diagnostics

## F200 B Type from 16 to 63 A

Residual current tripping thresholds according to frequency

**F200 B 30 mA**

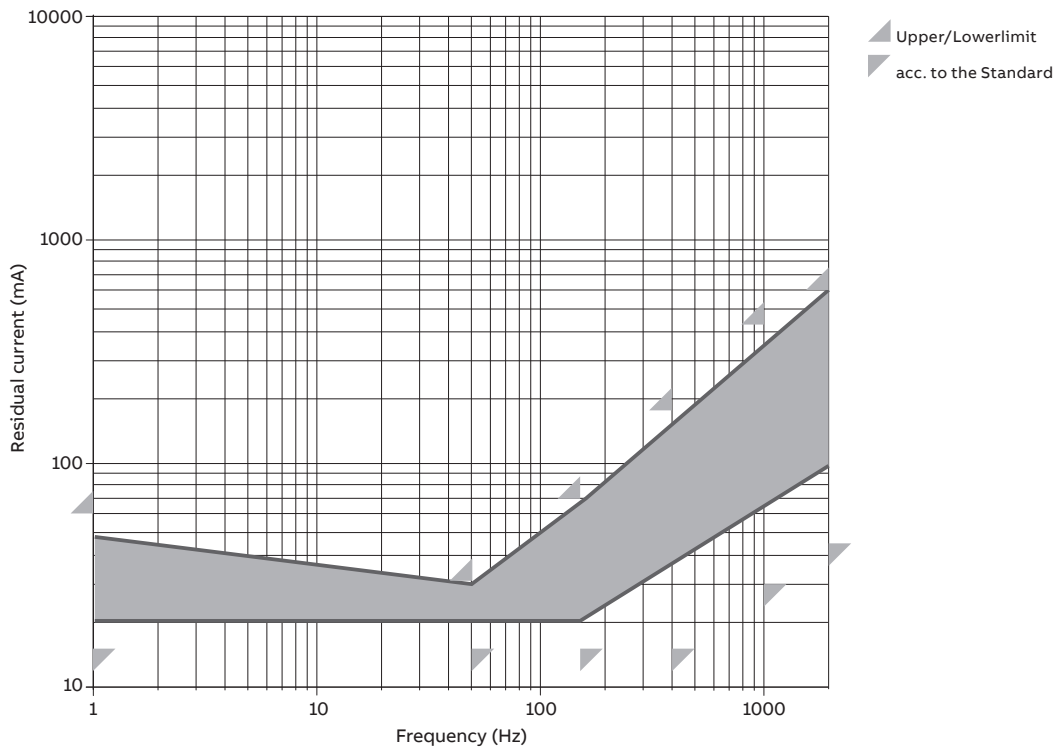

**F200 B 300 mA**

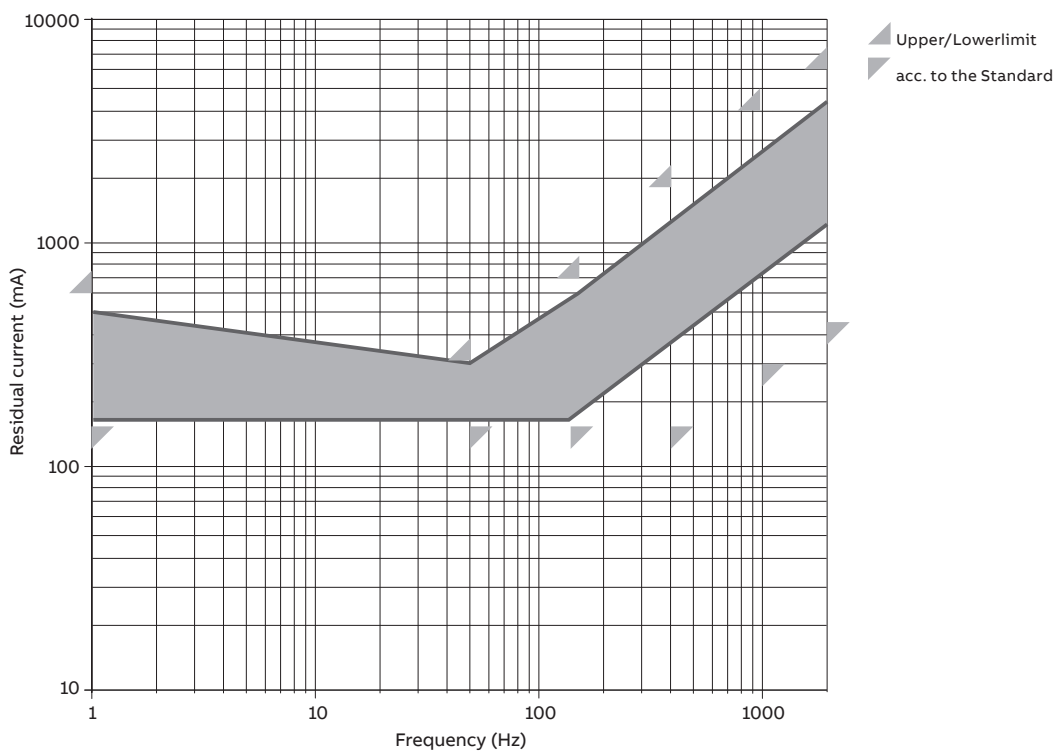

F200 B TYPE DATA SHEET

F200 B 500 mA

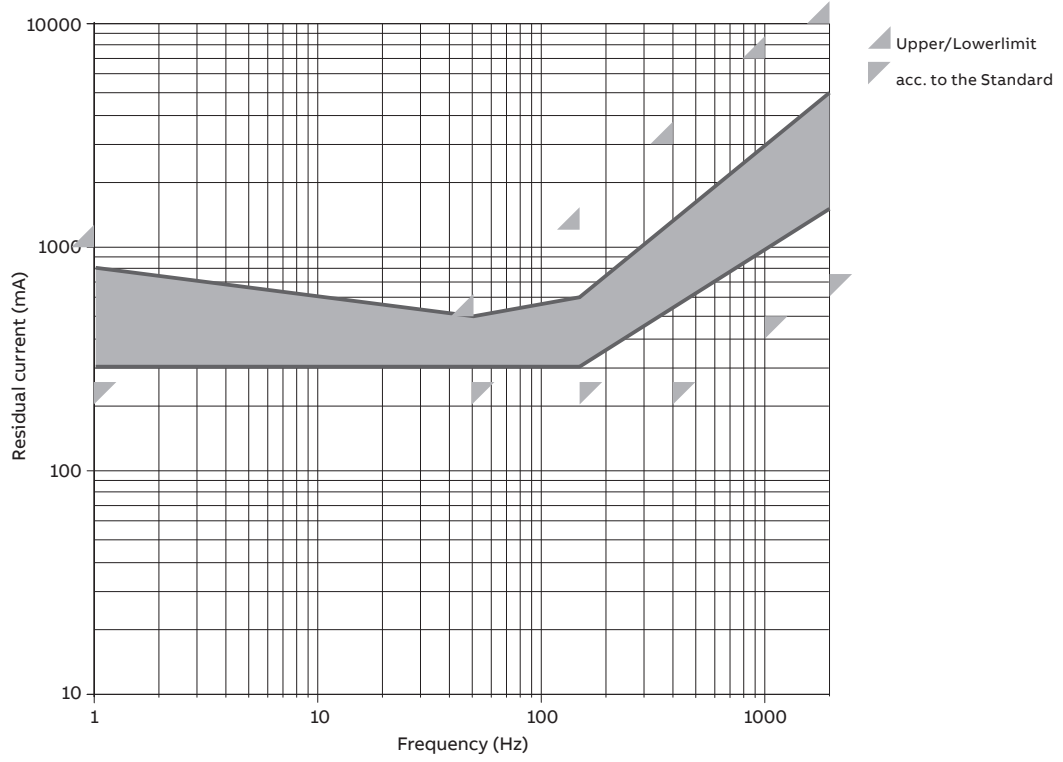

## F200 B high ratings

Residual current tripping thresholds according to frequency

**F204 B 30 mA**

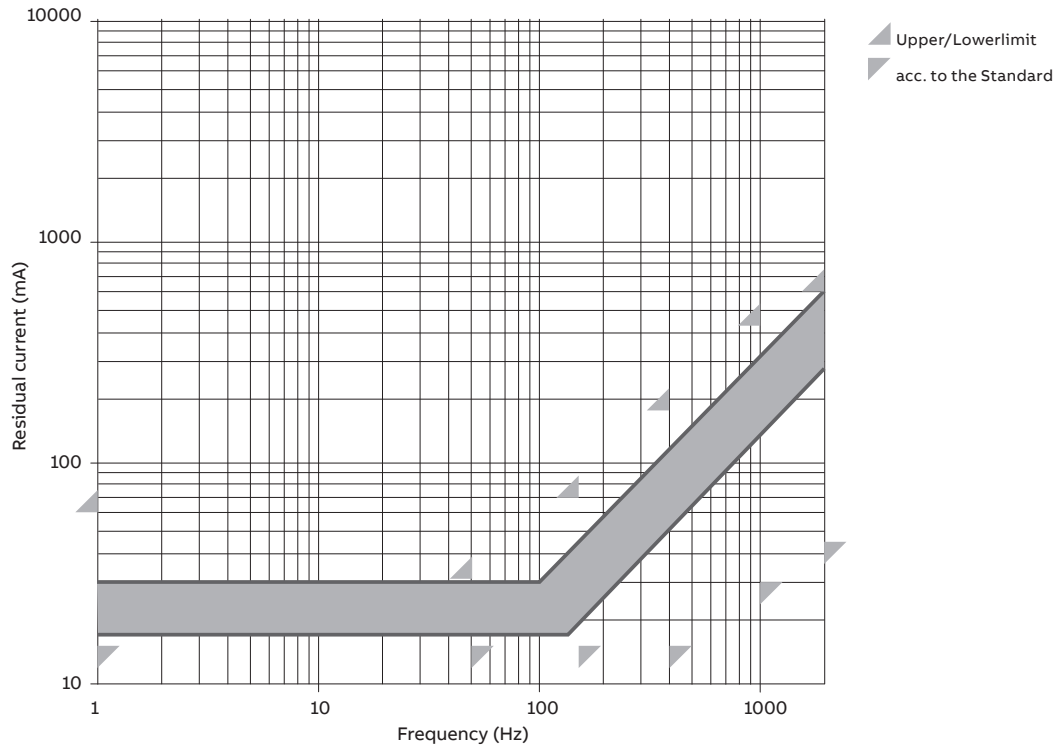

**F204 B 300 mA**

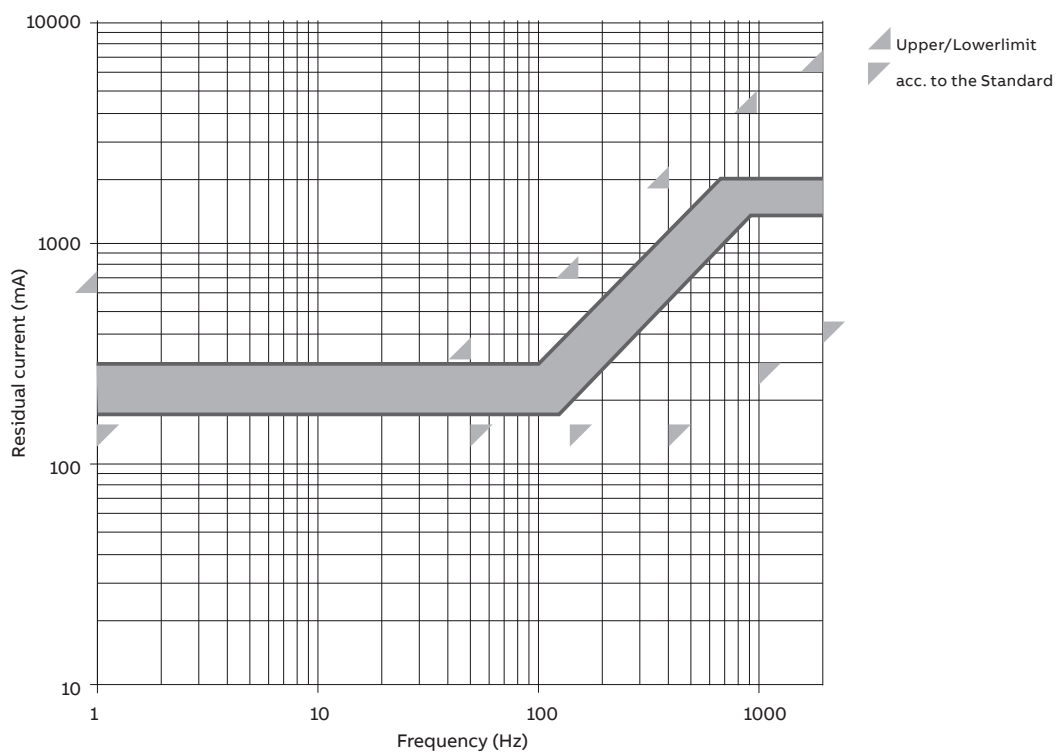

F204 B 500 mA

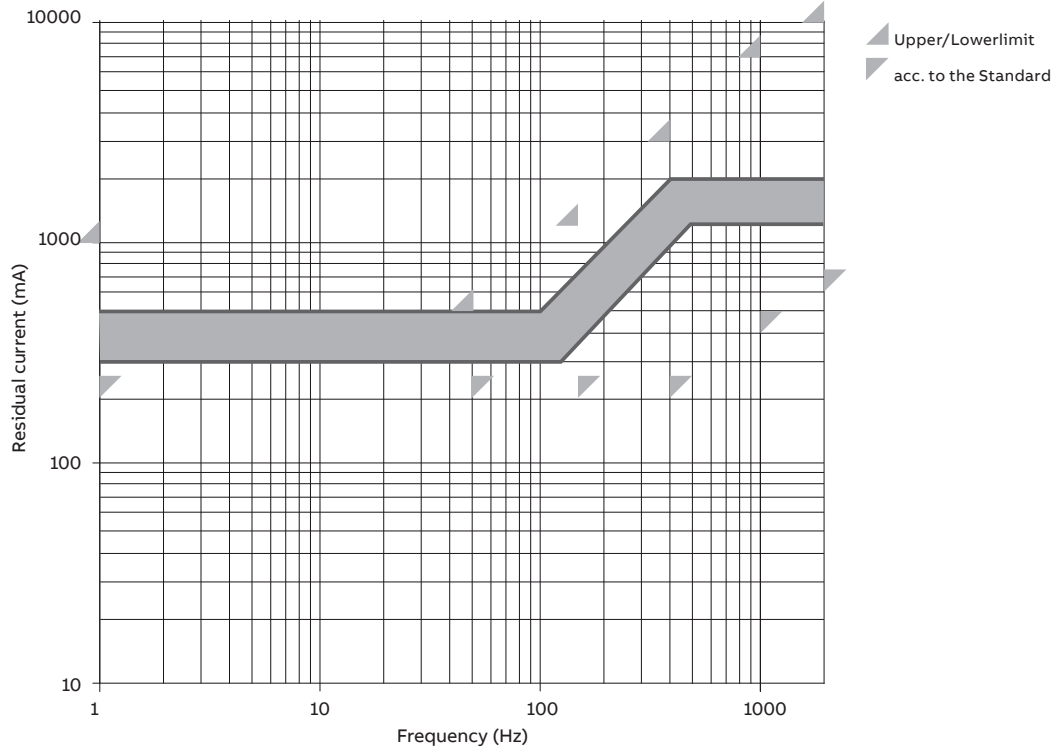

## F200 B Type

### Tripping times

Tripping times					
Type	Fault currents	Tripping time at			
	Alternating currents	1 x I $\Delta$ n	2 x I $\Delta$ n	5 x I $\Delta$ n	500 A
	Pulsating DC currents	1,4 x I $\Delta$ n	2 x 1,4 x I $\Delta$ n	5 x 1,4 x I $\Delta$ n	500 A
	Smooth DC currents	2 x I $\Delta$ n	2 x 2 x I $\Delta$ n	5 x 2 x I $\Delta$ n	500 A
Standard or short-time delay		Max. 0,3 s	Max. 0,15 s	Max. 0,04 s	Max. 0,04 s
Selectiv S		0,13 - 0,5 s	0,06 - 0,2 s	0,05 - 0,15 s	0,04 - 0,15 s

### Power Loss Values

Power Loss [W]	I <sub>n</sub> [A]	Per Pole	Total
	16	0,26	0,82
	25	0,65	1,58
	40	1,65	3,60
F202 B	63	4,14	8,58
	25	0,74	3,43
	40	1,92	6,95 (9,26*)
	63	4,80	15,6 (17,9*)
F204 B	80	3,5	14
	125	7,5	34,8

\* 500 mA devices

### Derating in temperature for F200 B series

Max operating current depending on permanent ambient temperature of the residual current circuit breaker.

I <sub>n</sub> (A)	Temperature (°C)				
	-25...50	55	60	65	70
16A	16	16	16	16	16
25A	25	25	25	25	25
40A	40	40	40	40	32
63A	63	55	48	40	32





02

02 03  
Production line of the  
RCCB F200 Type B

03



## Auxiliary elements and accessories for MCBs and RCCDs

### Selection tables

#### F200 B Type from 16 to 63 A

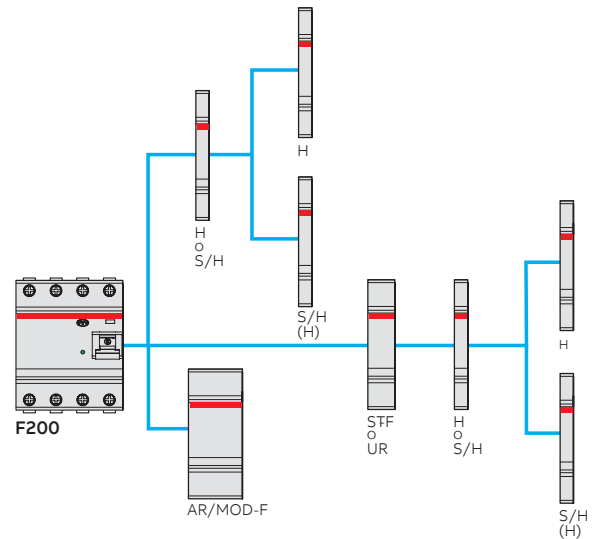
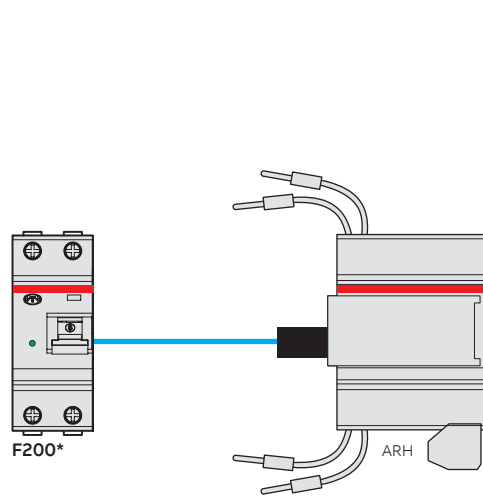

<b>ARH</b>	Home automatic resetting unit	F2C-ARH
------------	-------------------------------	---------

\* F202 30 mA or 100 mA (depending on ARH model), max 63 A

<b>H</b>	Auxiliary contact	S2C-H6R
<b>H-R</b>	Auxiliary contact	S2C-H6-...R
<b>S/H</b>	Signal/Auxiliary contact	S2C-S/H6R
<b>S/H (H)</b>	Signal/Auxiliary contact used as auxiliary contact	S2C-S/H6R
<b>UR</b>	Undervoltage release	S2C-UA
<b>AR</b>	Auto reclosing unit	F2C-ARI
<b>MOD-F</b>	Motor operating device	F2C-CM
<b>ST-F</b>	Shunt trip for F 200 RCCB	F2C-A

#### F200 B high ratings

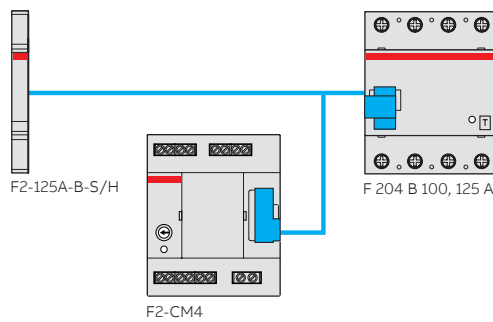

<b>F2-125A-B-S/H</b>	Signal/Auxiliary contact
<b>F2-CM4-MOD</b>	

## Overall dimensions and wiring diagrams

**F200 B Type from 16 to 63 A**  
All measurements in mm

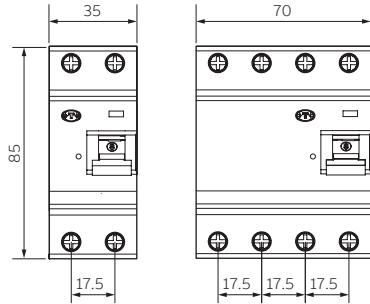

**F200 B high ratings**

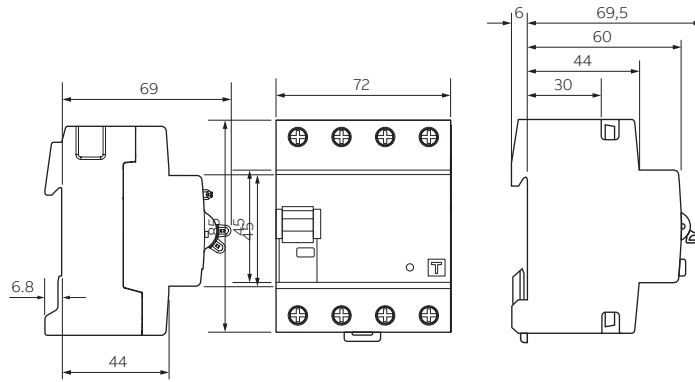

**F202 B16 - 63A**

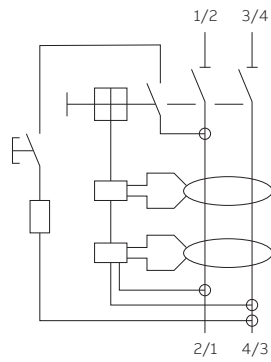

**F204 B25 - 63A**

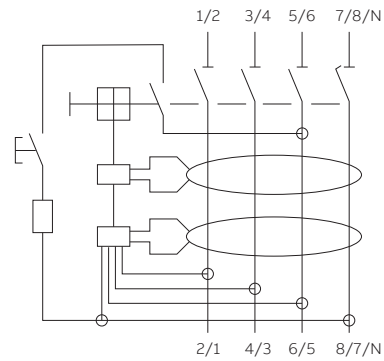

**F204 B 80A**

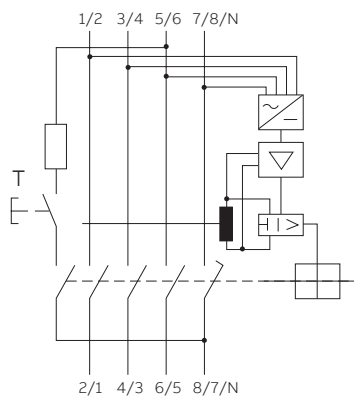

**F204 125A Neutral left**

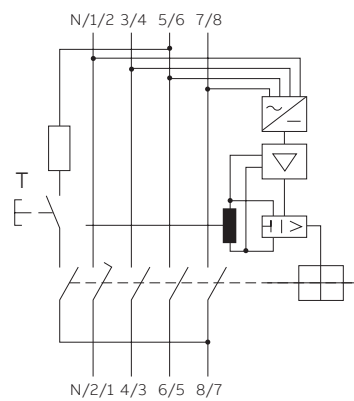



**ABB S.p.A.**  
Electrification Products Division  
BU Building Products

**[www.abb.com/lowvoltage](http://www.abb.com/lowvoltage)**

We reserve the right to make technical changes or modify the contents of this document without prior notice. With regard to purchase orders, the agreed particulars shall prevail. ABB AG does not accept any responsibility whatsoever for potential errors or possible lack of information in this document.

We reserve all rights in this document and in the subject matter and illustrations contained therein. Any reproduction, disclosure to third parties or utilization of its contents – in whole or in parts – is forbidden without prior written consent of ABB AG. Copyright © 2020 ABB  
All rights reserved

9AKK107991A7569 - 02.2021

